

ALUMINUM TRAIL ENGINE GUARD

Ref.: 2CP090087A



CROSSPRO
PROTECTION PARTS

ASSEMBLY INSTRUCTION / INSTRUÇÃO DE MONTAGEM

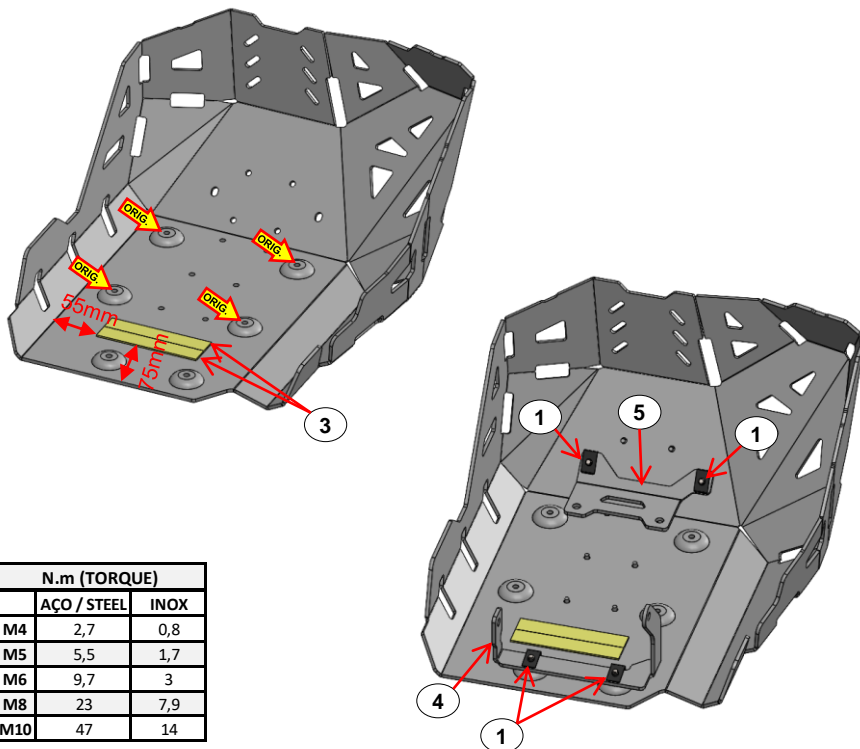
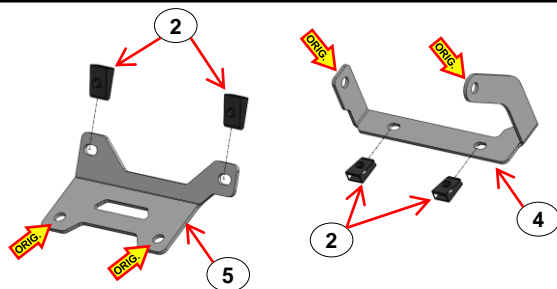
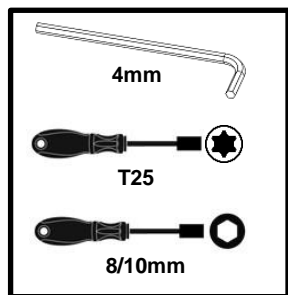

N.m (TORQUE)		
	AÇO / STEEL	INOX
M4	2,7	0,8
M5	5,5	1,7
M6	9,7	3
M8	23	7,9
M10	47	14

5	Fixação Inox / Inox Clamp	B87A	1
4	Fixação Inox / Inox Clamp	A87A	1
3	Tela Protetora / Protective Strip	120mm	2
2	Mola de Friso / Clip Inox	M6	4
1	Paraf. Cabeça Redonda Sext. Int. c. FA / Screw Round Head With Washer False	M6x16 - ISO 7380	4
ITEM Nº:	COMPONENTE (COMPONENT):	DESCRIÇÃO (DESCRIPTION):	QUANT.:
ACESSÓRIOS (ACCESSORIES)			



English:

- Tight all screws.

Français:

- Serrer toutes les vis.

Português:

- Apertar todos os parafusos.

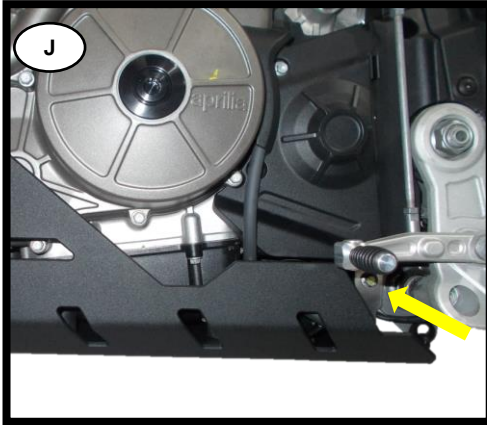

- English:**
- Tighten the origin screw of the fixation.
- Français:**
- Serrer la vis d'origine de la fixation.
- Português:**
- Apertar parafuso de origem da fixação.

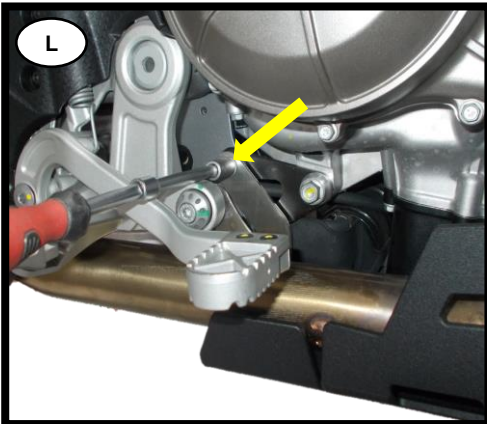

- English:**
- Tighten the origin screw of the fixation.
- Français:**
- Serrer la vis d'origine de la fixation.
- Português:**
- Apertar parafuso de origem da fixação.

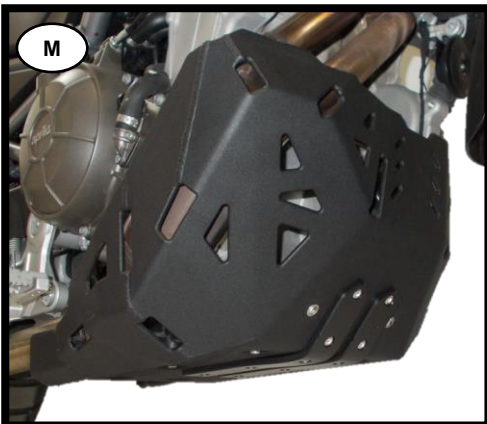

- English:**
- Tight all screws.
- Français:**
- Serrer toutes les vis.
- Português:**
- Apertar todos os parafusos.

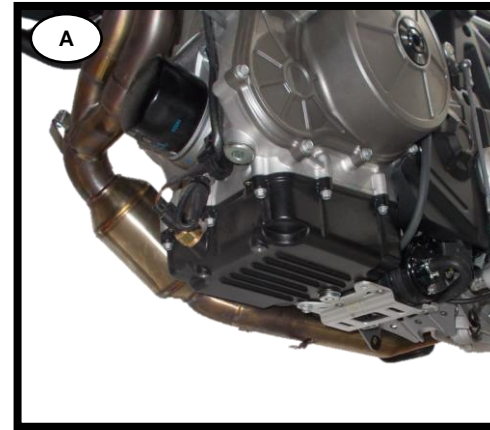

- English:**
- Remove the original protection.
- Français:**
- Retirer le protection d'origine.
- Português:**
- Retirar proteção de origem

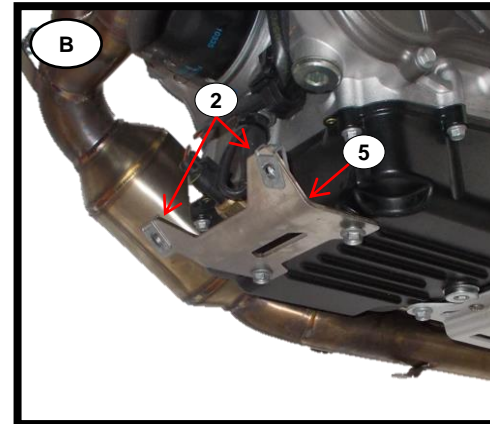

- English:**
- Apply item N°2 (Clip Inox – x2) on item N°5 (Inox Clamp – x1) and mount on the motorcycle with origin screws.
- Français:**
- Appliquer l'item N°2 (Clip Inox – x2) sur l'item N°5 (Fixation Inox – x1) et monter sur la moto avec les vis d'origine.
- Português:**
- Aplicar o item N°2 (Mola de Friso – x2) no item N°5 (Fixação Inox – x1) e montar na moto com os parafusos de origem.

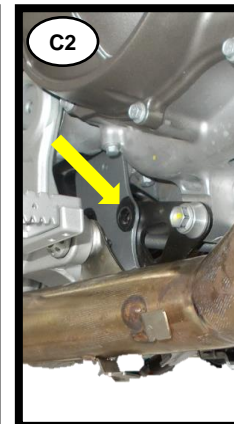

- English:**
- Remove the original Screws (2x) marked in the photo (left side Photo C1 and right side Photo C2).
- Français:**
- Retirez les vis d'origine (2x) marquées sur la photo (côté gauche Photo C1 et côté droit Photo C2).
- Português:**
- Remover os Parafusos de origem (2x) marcados na foto (lado esquerdo foto C1 e lado direito foto C2).

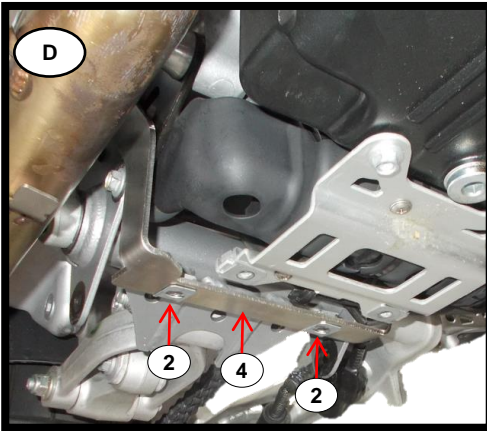

English:

- Apply item N°2 (Clip Inox – x2) on item N°4 (Inox Clamp – x1) and mount on the motorcycle with origin screws.

Français:

- Appliquer l'item N°2 (Clip Inox – x2) sur l'item N°4 (Fixation Inox – x1) et monter sur la moto avec les vis d'origine.

Português:

- Aplicar o item N°2 (Mola de Friso – x2) no item N°4 (Fixação Inox – x1) e montar na moto com os parafusos de origem.

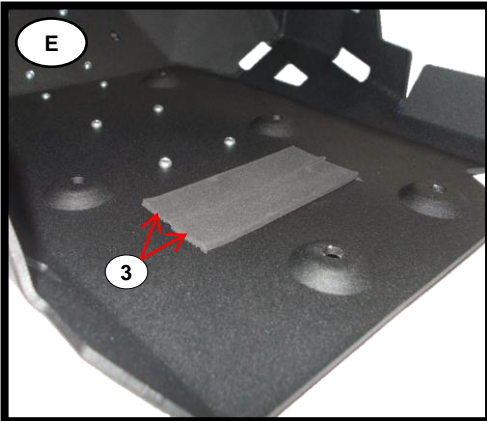

English:

- Apply item N°3 (Protective Strip – x2) according to the assembly instruction.

Français:

- Appliquer l'item N°3 (Bande de Protection – x2) selon les instructions de montage.

Português:

- Aplicar o item N°3 (Tira Protetora – x2) de acordo com a instrução de montagem.

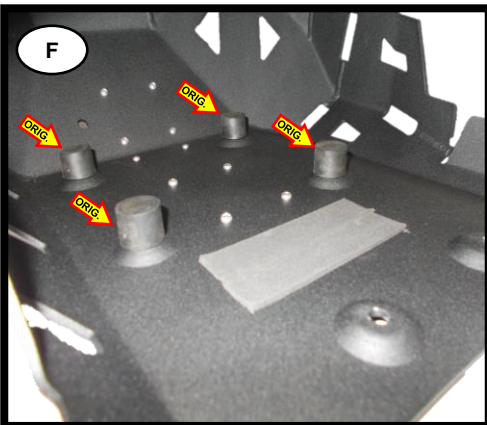

English:

- Apply original silent block and nut on the protection (4x).

Français:

- Appliquer le silentbloc et l'écrou d'origine sur la protection (4x).

Português:

- Aplicar sinobloco e porca de origem na proteção (4x).

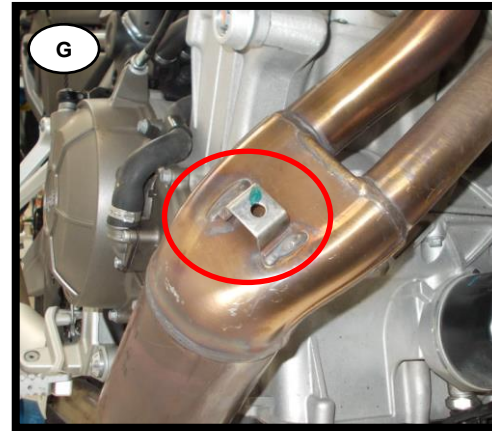

English:

- Remove origin clip inox.

Français:

- Retirer clip inox origine.

Português:

- Remover mola de friso de origem.

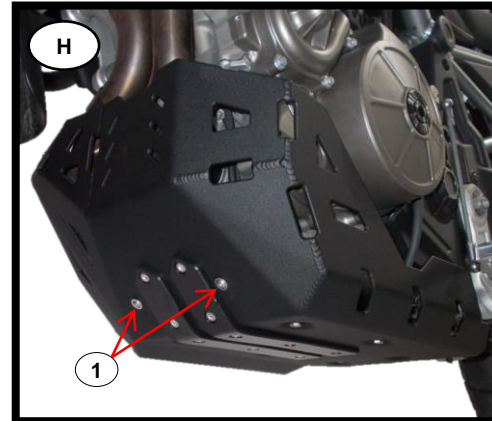

English:

- Mount protection on the motorcycle and apply item N°1 (Screw – x2).

Français:

- Monter la protection sur la moto et appliquer l'item N°1 (Vis – x2).

Português:

- Montar proteção na moto e aplicar o item N°1 (Parafuso – x2).



English:

- Apply item N°1 (Screw – x2).

Français:

- Appliquer l'item N°1 (Vis – x2).

Português:

- Aplicar o item N°1 (Parafuso – x2).